

General information

PVS13420200908

The CMH HT load cell, built in stainless steel, has been designed for the industrial weighing of tanks, silos, tanks, tanks, ladles, etc. and it is ideal for working in harsh environments or where a high temperature is present. It has excellent characteristics of precision, strength and maximum resistance to impacts and overloads. It is mainly used in the food, chemical, pharmaceutical and steel industries. The cell can be customized according to customer needs.



Suggested related products

A highly performing weighing system must be accurate, perfectly calibrated and well maintained. In order to improve the load cell performance and to optimize its functioning, you may need the following products:

Weight Transmitter [DAT 1400](#)

Weight Indicator [MCT 1302](#)

High Temperature load cell [C2G1 HT](#)

High Temperature load cell [PRR HT](#)

High Temperature load cell [PSPRX HT](#)

High Temperature load cell [SB HT](#)

All indicated data may be changed without notice.
All the measures indicated are expressed in millimeters (mm).

Technical specifications

PVS13420200908

Rated load RL:	2, 6, 10, 15, 20, 30, 40, 50, 60, 100, 150, 200 t
Combined error:	±0.1 % RL
Repeatability:	±0.05 % RL
Creep (20 minutes):	±0.03 % RL
Safe overload:	150 % RL
Ultimate overload:	> 300 % RL
Material:	Stainless steel AISI 17-4PH
Degree of protection:	IP65
Deflection:	0.3 mm
Compensated Temperature:	-10 ÷ +90 °C
Temperature range:	-35 ÷ +150 °C
Temperature effect on zero balance:	±0.005 % RL/°C
Temperature effect on output:	±0.005 % RL/°C
Rated output RO:	2 mV/V
Insulation resistance:	> 5000 MOhm
Input resistance:	350 ±20 Ohm
Output resistance:	350 ±5 Ohm
Recommended input:	5 ÷ 12 Vdc/ac

All indicated data may be changed without notice.
 All the measures indicated are expressed in millimeters (mm).

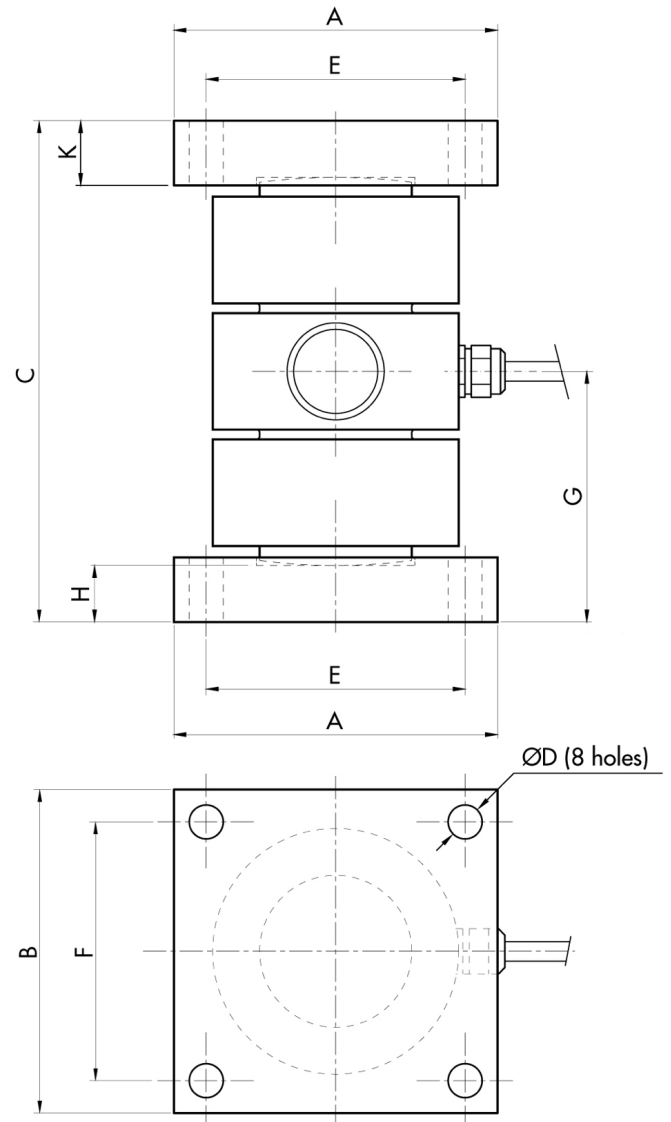
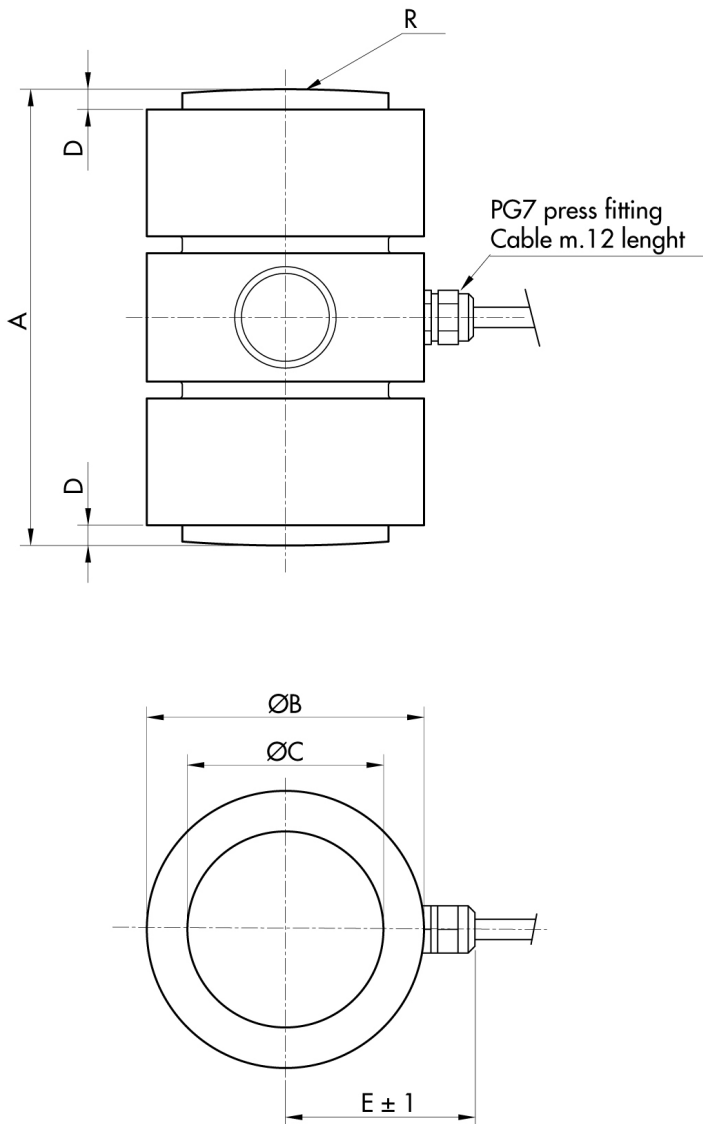

RANGE	A	ØB	ØC	D	E	R
2-10 t	104	52	30	6	42	180
20-30 t	105	52	30	8	42	200
40-60 t	120	76	47	8	53	180
100 t	135	82	58	8	56	400
150-200 t	160	125	87	8	77	400

RANGE	A	B	C	ØD	E	F	G	H	K
2-10 t	80	80	120	6.5	68	68	60	8	10
20-30 t	100	100	140	10.5	80	80	70	17.5	20
40-60 t	100	100	160	10.5	80	80	80	17.5	23
100 t	120	120	200	10.5	100	100	100	32.5	35
150-200 t	150	150	250	12.5	125	125	125	45	49

All indicated data may be changed without notice.
All the measures indicated are expressed in millimeters (mm).